



ZLINE



FIRECLAY SINKS

Installation Guide
and Users Manual



This product can expose you to chemicals including nickel, which is known to the State of California to cause cancer, and birth defects or other reproductive harm. For more information go to www.P65Warnings.ca.gov.

Even though the materials used in all ZLINE Kitchen and Bath products conform to all federal government regulations and all national product standards, California's Prop 65 requires all businesses to provide a "clear and reasonable warning" if one or more listed chemicals may be present in the product, even if that chemical is present in trace quantities



ZLINE

Each ZLINE fireclay sink is meticulously hand-crafted and Italian-made, offering a truly luxurious design and aesthetic. Constructed to be resistant to bacteria, stains, and cracks, these statement sinks are non-porous and naturally sound absorbing. Due to the way the high quality clay mixture is fired, ZLINE fireclay sinks are more durable than traditional ceramic sinks, allowing for a worry-free washing experience. Four layers of thick glaze creates the beautiful, shiny complexion seen on ZLINE fireclay sinks.

CONTENTS

● SAFETY INSTRUCTIONS	1
● ACCESSORIES	2
● SINK DIMENSIONS	3
● SINK INSTALLATION	11
● CARE AND CLEANING	12

SAFETY INSTRUCTIONS

- The installer and/or user must read, understand, and follow these instructions before installing the product. This product must be properly installed before it is used. If instructions are not followed, the manufacturer will not be held responsible for any problems or product malfunction. Failure to follow installation and/or operating instructions voids the warranty.
- We recommend that this product be installed by a certified plumber. In some states or provinces, it is a legal requirement for this type of product to be installed by a certified plumber, according to the plumbing and building codes effective in the region where the sink is used.
- DO NOT attempt to install this sink yourself. Injury could result from installing the unit due to lack of appropriate plumbing and technical background. Due to the size and weight of this sink, a two person installation is recommended.
- It is recommended that the cabinet maker waits until the sink is delivered to construct the cabinets.
- Shut off the water valves before installing the sink or doing any maintenance.
- Disconnect the power to the dishwasher and garbage disposal.
- Open the sink packaging and verify that the sink is in perfect condition. Put the sink back in its packaging to protect it until time of installation. Do not install the sink if defects are found. Call customer service at 1-614-777-5004 for assistance. Please keep in mind that ZLINE fireclay sinks are handcrafted and have a +/- 2% variance on the dimensions.

ACCESSORIES

All apron mount models come with a strainer and utility rack.



Strainer

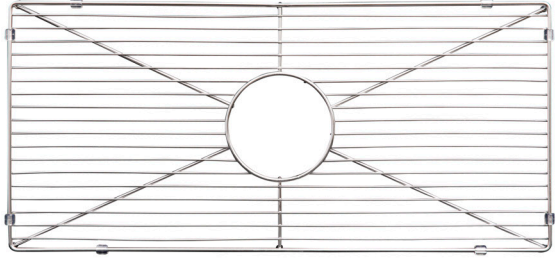

Utility Rack

SINK DIMENSIONS

Fireclay Sink Single Bowl

FRC5117-30 (Apron Mount)

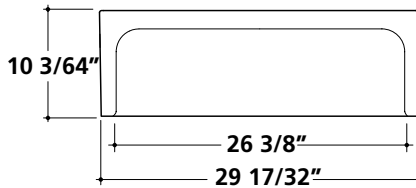
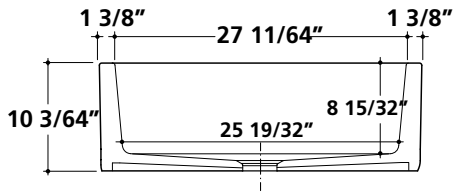
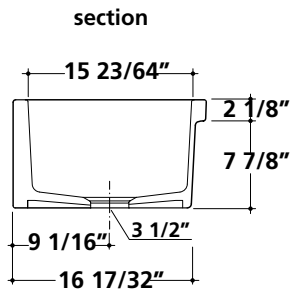
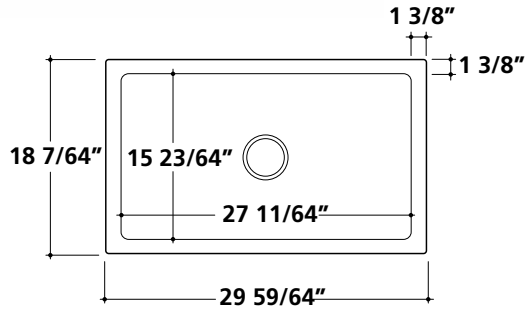

SINK DIMENSIONS

Fireclay Sink Single Bowl

FRC5119-30 (Apron Mount)

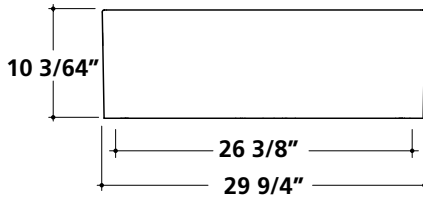
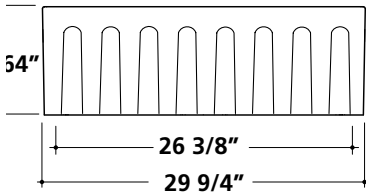
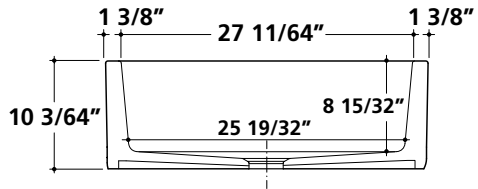
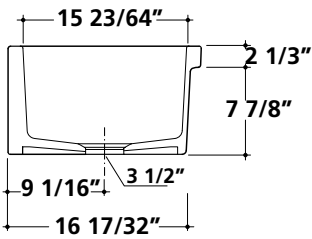
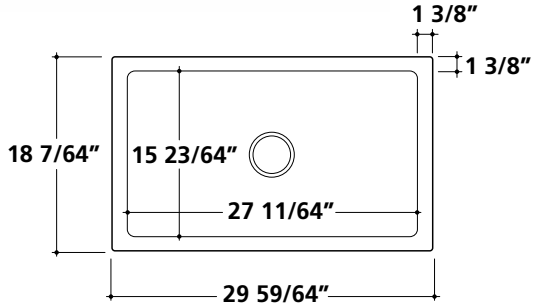

SINK DIMENSIONS

Fireclay Sink Single Bowl

FRC5120-24 (Apron Mount)

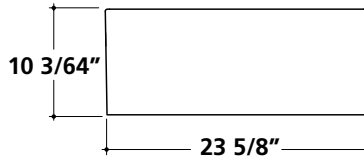
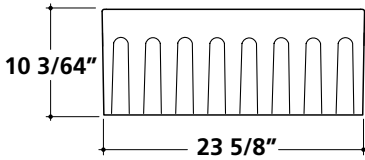
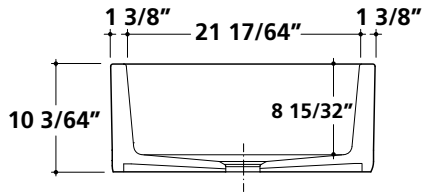
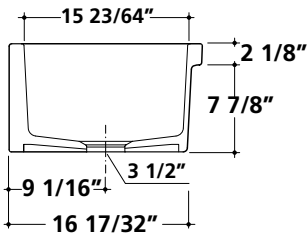
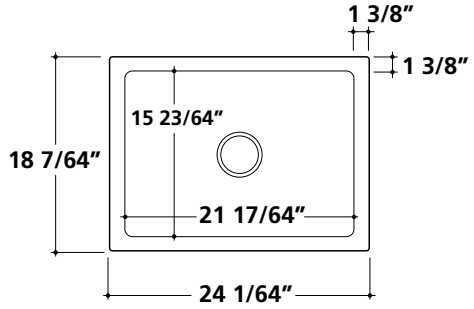

SINK DIMENSIONS

Fireclay Sink Double Bowl

FRC5121-36 (Apron Mount)

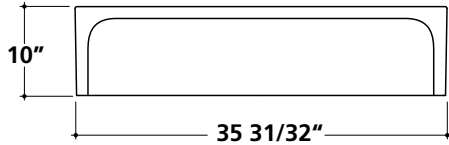
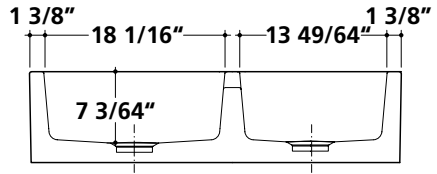
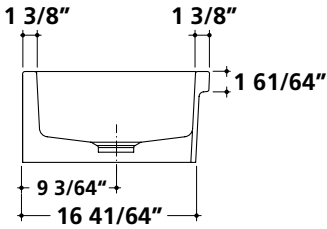
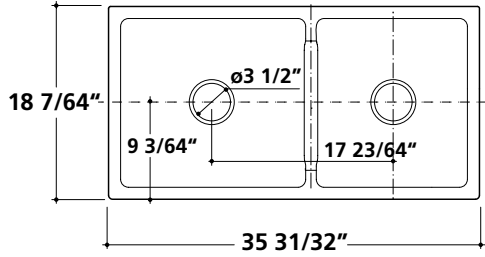

SINK DIMENSIONS

Fireclay Sink Single Bowl

FRC5122-36 (Apron Mount)

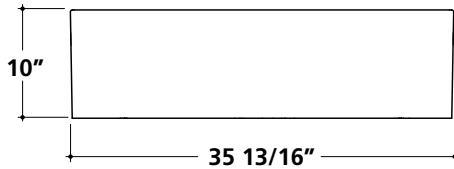
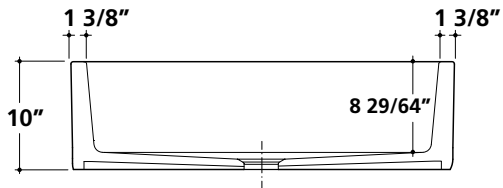
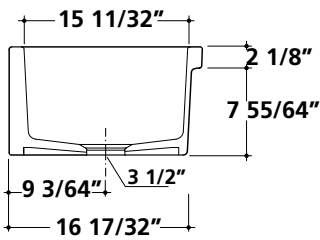
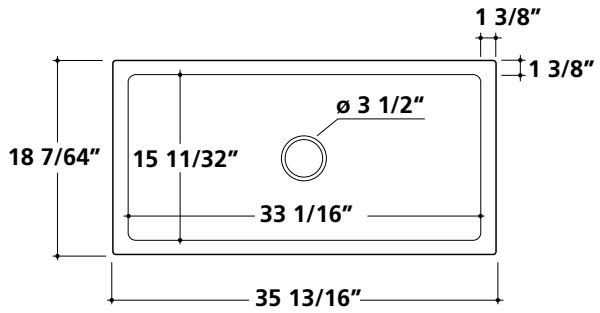

SINK DIMENSIONS

Fireclay Sink Single Bowl

FRC5123-36 (Dual Mount)

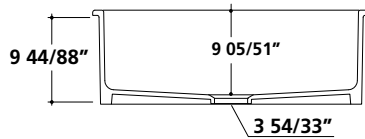
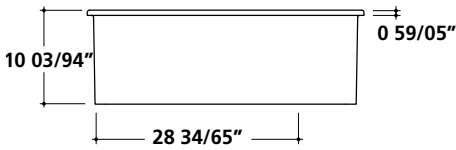
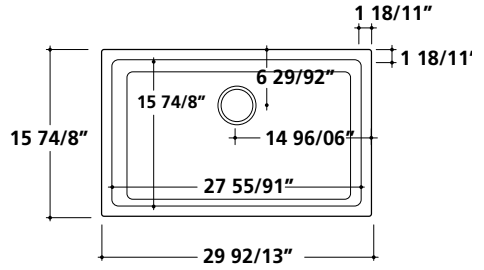

SINK DIMENSIONS

Fireclay Sink Single Bowl

FRC5124-24 (Dual Mount)

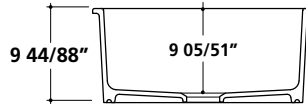
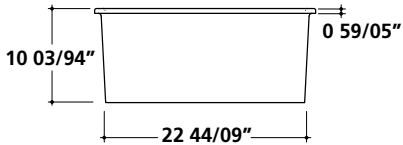
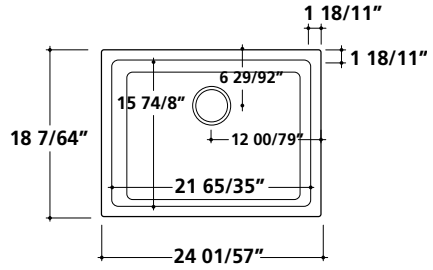

SINK DIMENSIONS

Fireclay Sink Single Bowl

FRC5131-33 (Apron Mount)

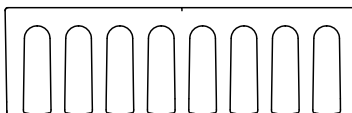
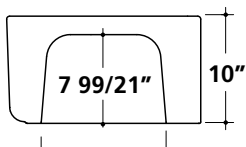
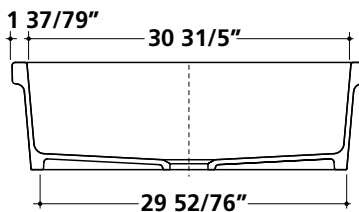
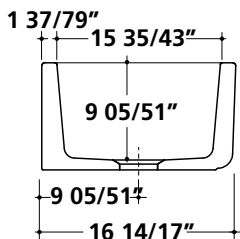
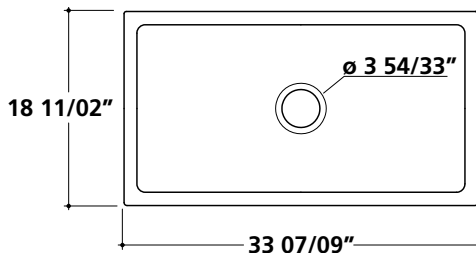

Before Installation

Inspect the sink for any visible defects. Do not install the sink if defects are found. Call customer service at 1-614-777-5004 for assistance. Please keep in mind that ZLINE fireclay sinks are handcrafted and have a +/- 2% variance on the dimensions.

Installation

1. Preparing the Cabinets

Make sure that the tank will not interfere with cabinet doors or panels. Ensure that there is enough space for the water supply installation.

2. Build a Support Frame

Fireclay sinks need support due to their weight. Install 2x4s underneath the sink to reinforce it. Create both vertical and horizontal supports.

3. Insert the Sink

Insert the sink on the support frame. Apply silicone-based sealant to each corner between the frame and the sink.

Easy Cleaning Instructions

Fireclay sinks can be washed with dish soap and water. A rinse and towel drying after each use will take care of most everyday clean ups.

Scratches

Matte finishes tend to show more markings. Markings that appear to be scratches are typically residue left by metal cutlery or pots and pans. It is recommended to use a utility grid (included with apron mount models) to reduce the appearance of markings. Markings can be removed with a diamond sponge or a Scotch-Brite™ pad and baking soda.

Chips

Fireclay sinks are extremely resistant to chips, but if any small chips are found, there are repair kits available at most local hardware stores.

Food

Food can easily become stuck in the corners of the fireclay sink due to its shape. Rinse out all food particles to keep the sink clean.

Dos and Dont's

Do rinse thoroughly after each use.

Do towel dry after each use to prevent mineral deposits from building up on the surface of the sink.

Do clean the sink once a week.

Do wax the sink once a month.

Do Not allow soap or other household cleansers to dry on the surface of the sink.

Do Not use abrasive cleaners to clean your sink.



ZLINE
KITCHEN AND BATH

Three Locations:

350 Parr Circle
Reno, NV 89512

916 Delaware Avenue
Marysville, OH 43040

319 Rowland Mill Road
Bruceton, TN 38317

www.zlinekitchen.com

1-614-777-5004